



Spiritual Lessons from the Life of Moses

Lesson 10 – The Israelites at Rephidim

Exodus 17

<https://d3h6k4kfl8m9p0.cloudfront.net/stories/PIDbOjryanTSIM9gDRKhQw.jpg>

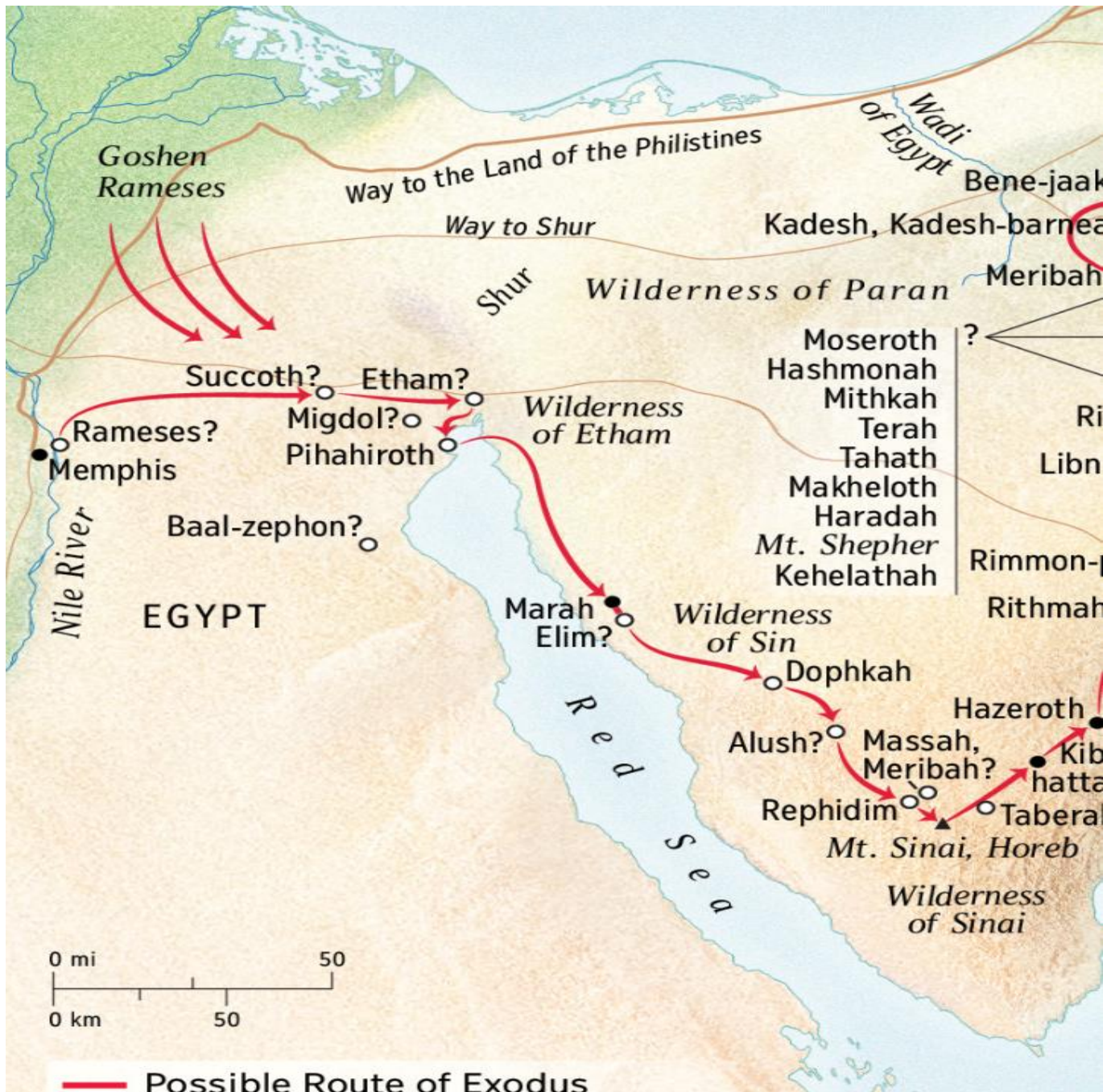

(1) Background: From the Wilderness of Sin, the Israelites journeyed to Rephidim.

(2) The Israelites continued to grumble over the lack of water, quarrelled and wanted to stone Moses at Massah (see map).

https://cms-imgp.jw-cdn.org/img/p/1001061223/E/art/1001061223_E_sub_xl.jpg

(3) Watch video Chap 17, Bible Movie app, start to 01:46:

<https://biblemovie.subspla.sh/ac0de7e>

Please watch with discretion as parts of the movie may be inaccurate.

Note:

Despite God's provisions, the Israelites cried out for lack of water again.



Exodus 17 v 1-7
When they camped at Rephidim there was no water to drink. They complained and quarrelled with Moses demanding, 'Give us water to drink!' 'Why do you quarrel with me?' Moses asked. 'Why do you test God?'

<https://www.freebibleimages.org/>



Exod 17:4

Moses cried out to God for help. 'What am I to do with these people? They are ready to stone me.' 'Go out to the people and take the leaders (elders) with you to the rock at Horeb,' God replied. 'Carry your staff with you and strike the rock.'

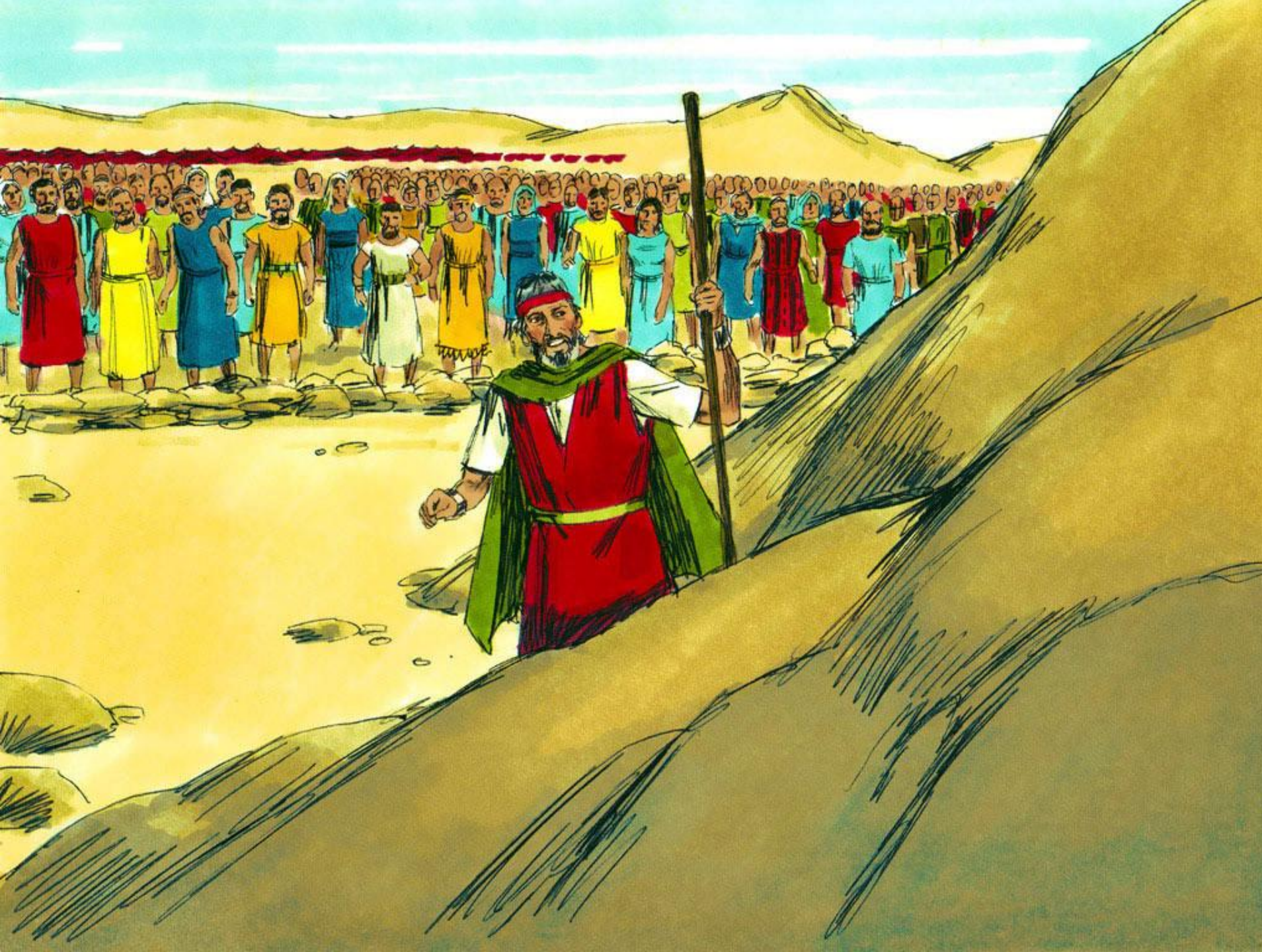

Exod 17: 5

The leaders followed Moses to the rock at Horeb and watched as he struck it with his staff.

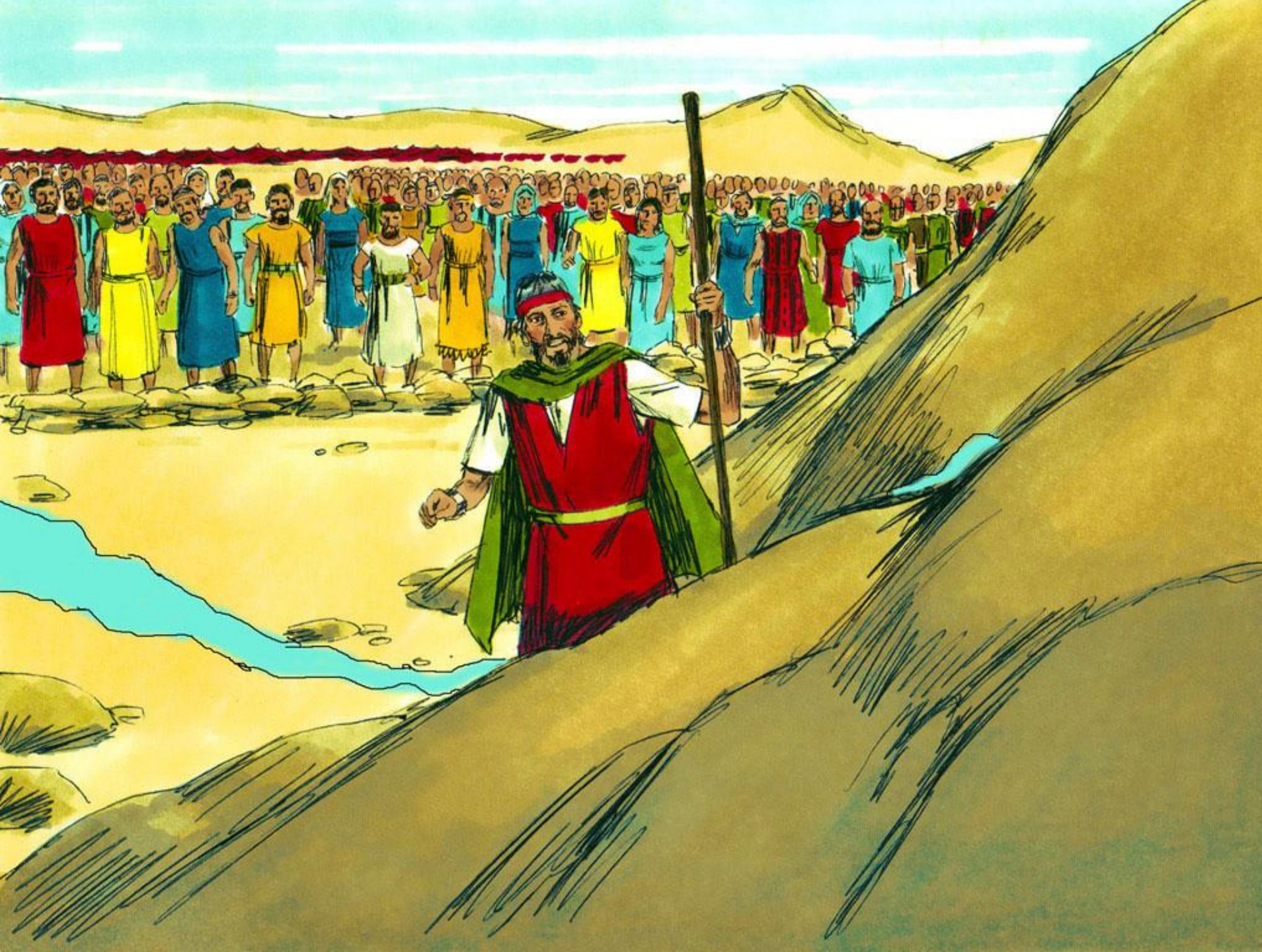

Water burst out of the rock, just as God had promised.



Exod 17

Everyone drank the water. Moses called the place 'Massah and Meribar' because people had doubted God by asking, 'Is the Lord with us or not?' (In Hebrew, Massah means 'testing' and Meribar means 'quarrelling').

God had kept His promise and provided food and water in the desert.



Exodus 17 v 8

A group of desert nomads, known as the Amelakites, came up behind the travelling Israelites and started attacking the weak and elderly people travelling at the back of the convoy.



Map of the battle of Amalekites at Rephidim

<http://godswarplan.com/wp-content/uploads/2016/10/05.00-REPHIDIM-loc.jpg>



Exod 17:9

Moses told a young, tough leader called Joshua to choose some strong fighting men to go out and fight the Amalekites the following day.



Exod 17: 10

The next day they set off. Moses told them he would stand on top of a hill with the staff of God held high in his hands.



Exod 17:
Moses, along
with Aaron and
a leader called
Hur, went to
the top of a hill
to call on God's
power in the
battle.



Exod 17:11
Moses
held his
hands up.



Exod 17: 11

While Moses' hands were held high, Joshua and his men began winning the battle.



Exod 17: 11

But as Moses
got tired and
lowered his
hands



Exod 17: 11...
the enemy
started
winning.



Exod 17: 12

As Moses became exhausted, Aaron and Hur sat him on a large stone and helped him keep his hands high. They supported him all through the day until sundown.



Exod 17:

Joshua and his men fought victoriously all through the day as Moses' hands were kept high.

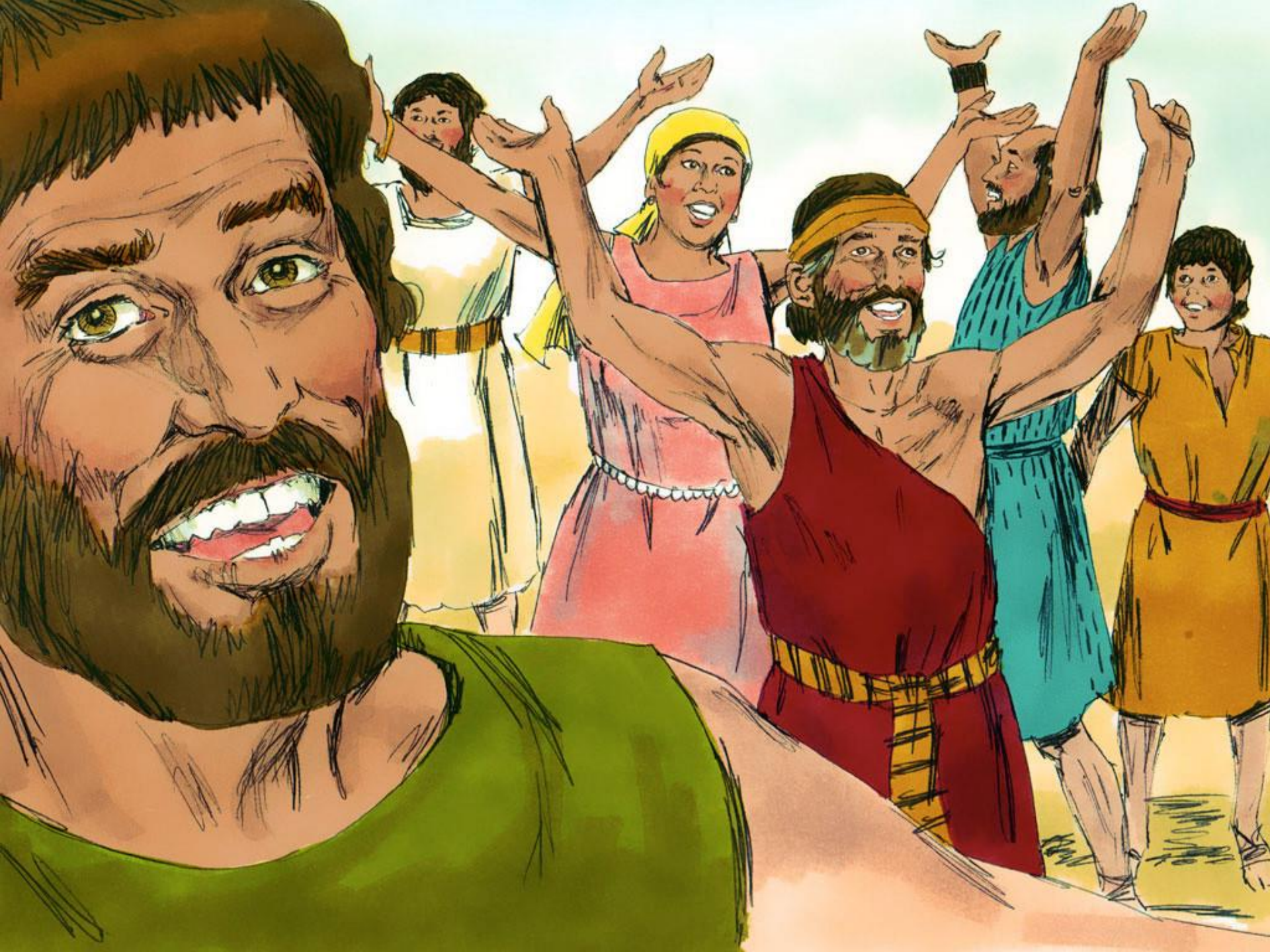

Exod 17: 13

That evening
the battle was
finally won

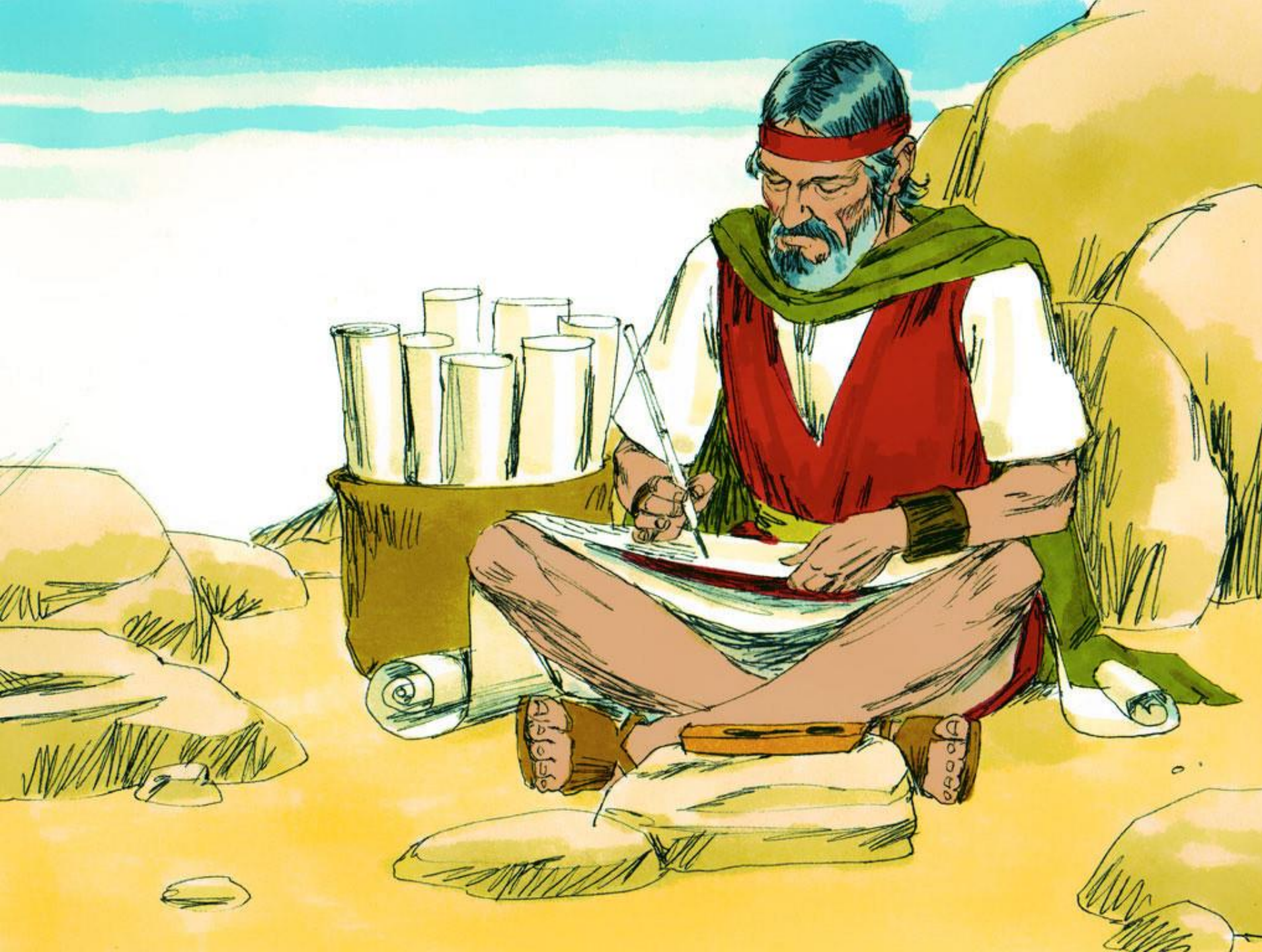

Exod 17: 14

God told Moses to write something on a scroll that Joshua and the people could read and be reminded of later. 'I will completely defeat the Amalekites so that they will no longer exist.'

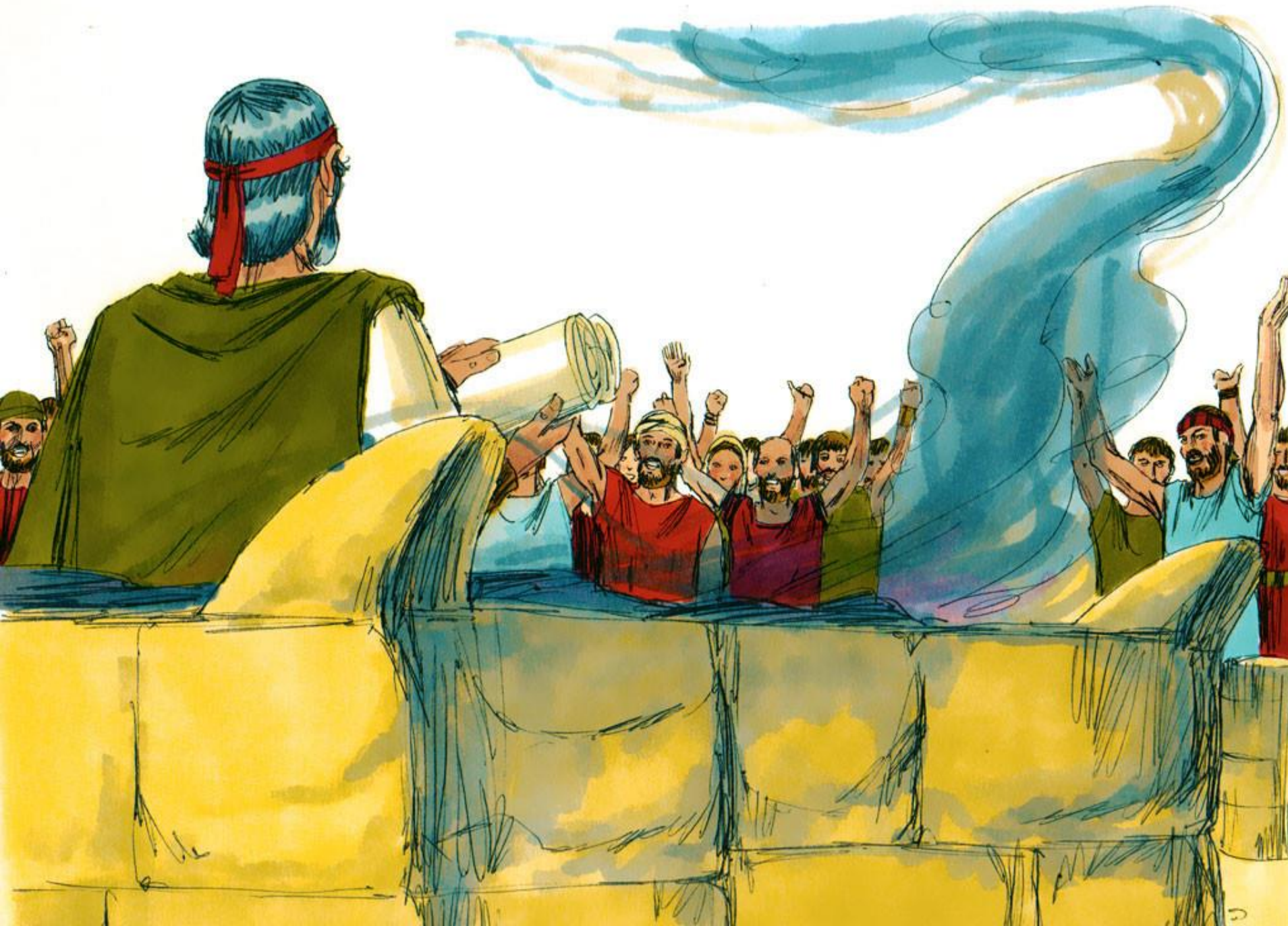

Exod 17: 15

Moses built an altar and called it 'The Lord is my Banner'. Then he declared, 'As the Amalekites attacked us, the Lord will be at war with them from now on.'



Exod 19:2

With their enemies defeated, God led His people to the foot of Mount Sinai where they set up camp.

(3) Spiritual Lessons

(a)The Israelites' bad behaviour to Moses for lack of water (Exod 17:1-4)

- Time and again the Israelites grumbled against Moses for their lack:
 - at Marah,
 - at the Desert of Sin and
 - at Rephidim
- Now, they were so angry that they were prepared to stone Moses.
- Despite their bad behaviour, God was patient and merciful and provided water to them.

Now what for us:

- We must not behave the same way as the Israelites.
- They were stubborn and unwilling to learn from their past experiences with the Lord.
- Whenever we meet with difficulties, we must go to the Lord in prayer:
 - Be thankful for past deliverance;
 - Seek forgiveness for our sins with a broken spirit and contrite heart;
 - Humbly seek help for our trouble;
 - Wait upon the Lord to help us in accordance with His will.
- From God's provision to the Israelites, we learn that our God is always patient and merciful to us. Hence, we can always go to God for help. He will be patient and merciful with us.

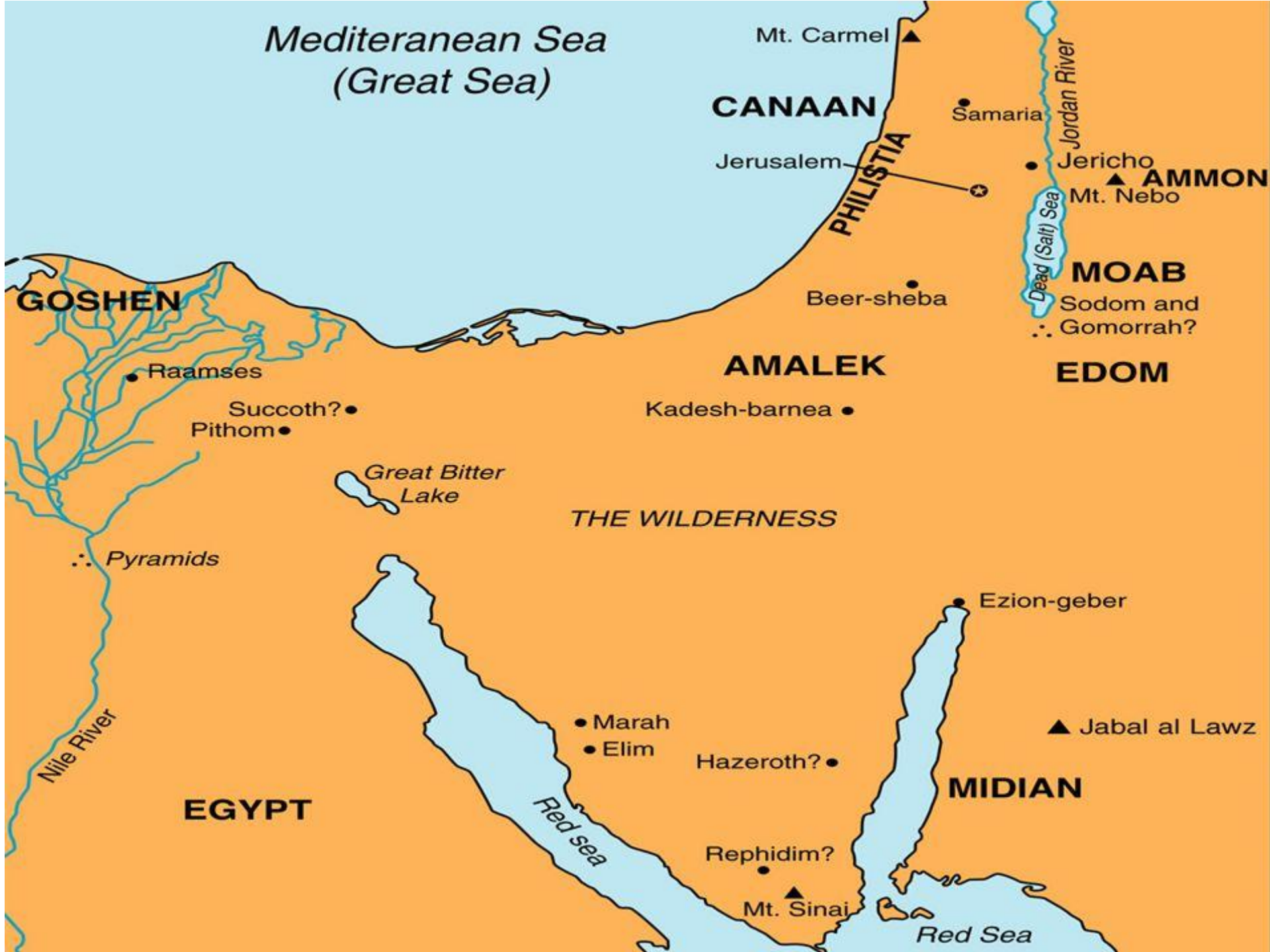

(4) The battle of the Amalekites

Map of Amalek

https://www.google.com/url?sa=i&url=https%3A%2F%2Fgbu-presnenskij.ru%2Felektronnoe-obraschenie%2F%3Fu%3Dmap-of-the-amalekites-territory-bible-history-qq-0LWWyCm&psig=AOvVaw3QBAM8fZ9KiPuMVg-OTcvy&ust=1710486797644000&source=images&cd=vfe&opi=89978449&ved=2ahUKewizlCBmvOEAX1e2wGHS12D_4QjRx6BAgAEBc

(a) Who were the Amalekites?

The Amalekites were the descendants of Esau. Hence, the Israelites and Amalekites were distant relatives.

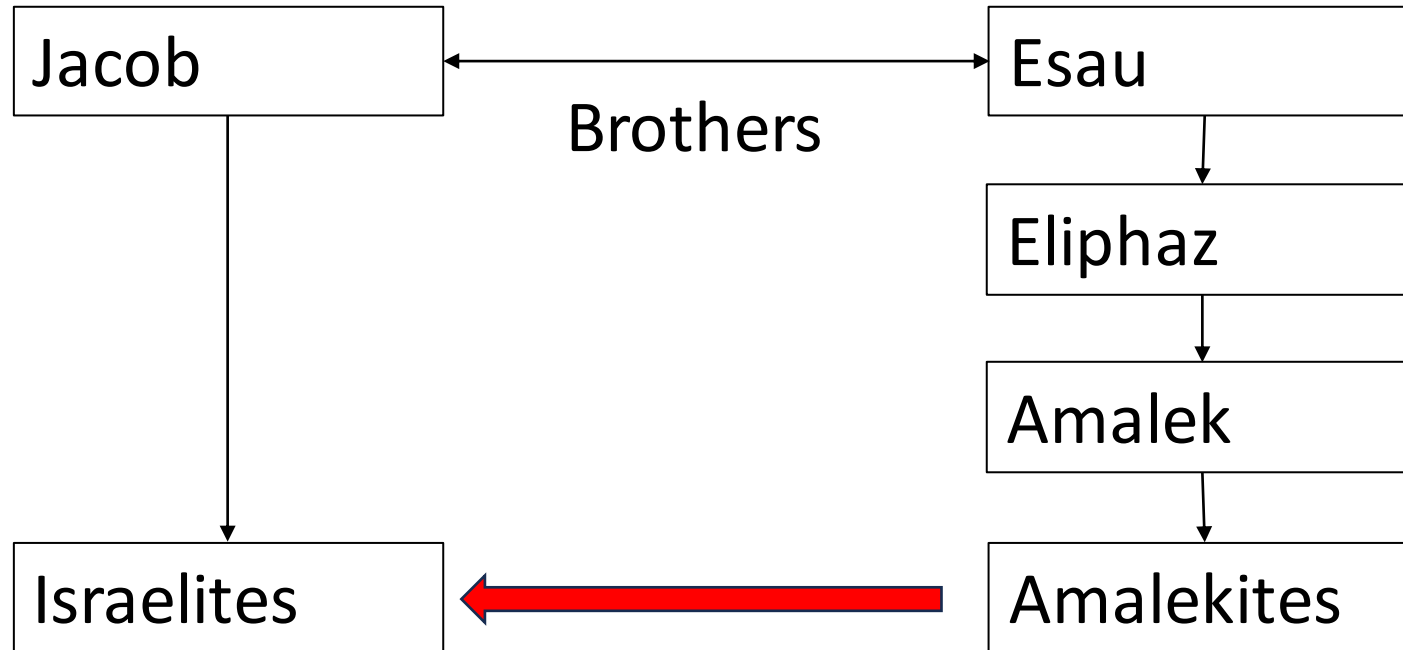

The Amalekites attacked
the Israelites at Rephidim

(b) Why did the Amalekites attack the Israelites?

Exod 17:8:

“Then came Amalek, and fought with Israel in Rephidim.”

1 Sam 15:2-3:

”² Thus saith the LORD of hosts, I remember that which Amalek did to Israel, how he laid wait for him in the way, when he came up from Egypt.

³ Now go and smite Amalek, and utterly destroy all that they have,...”

(c) God's judgment (punishment) against the Amalekites

- The Amalekites were the arch enemy of the Israelites:
 - Exodus 17:8
 - Numbers 14:41-45
 - Judges 3:12-14;
 - Judges 6:3,33-35
- God's judgment against the Amalekites:

1 Sam 15:2-3:

"² Thus saith the LORD of hosts, I remember that which Amalek did to Israel, how he laid wait for him in the way, when he came up from Egypt.

³ Now go and smite Amalek, and utterly destroy all that they have,..."

- **Now what for us:**
- Although God is a patient and merciful God, His patience and mercies are not inexhaustible. We see God's wrath and severe punishment in, for example:
 - Destruction of the Amalekites in 1 Sam 15:2, 3.
 - Destruction of Sodom and Gomorrah in Genesis 19:23.
 - Destruction of Jericho in Joshua 6:20.
- Those who met God's wrath and severe punishment:
 - Wicked
 - Unrepentant
 - Non-believers

(d) God's support for the Israelites against the Amalekites

- Although the Israelites had to fight the battle against the Amalekites, ultimately it was the Lord who gave the victory.
- God's sovereignty and Man's responsibility:
 - God will provide for all our needs, but we still have to work.

(5) Now what for us?

- We resolve our trouble through the following:
 - Practise 'God's sovereignty and man's responsibility'.
 - We seek God in prayer.
 - We do our part to resolve the issue but ultimately it is God's sovereign will for the matter to be resolved.
 - Hence, we must act righteously and seek His will to overcome the trouble.

S/N	Location	Complaints	God's action	Now what for us?
1.	Pi Hahiroth Exodus 14:2	That Moses brought the Israelites out to the wilderness to die. [They were hemmed in between the Red Sea and the Egyptian army]	<ul style="list-style-type: none"> • Parted the Red Sea for the Israelites to cross safely. • Destroyed the Egyptian army when they cross the Red Sea. 	<ul style="list-style-type: none"> • When we are in difficult situations, God is in control. • God will hear the cry of the righteous and deliver us.

S/N	Location	Complaints	God's action	Now what for us?
2.	Marah (Exod 15:23)	No water for 3 days. Bitter water at Marah.	God turned the bitter to sweet water.	Pray and trust God.
3.	Elim	NIL	God led them to Elim to rest. There were 12 springs and 70 palm trees.	After a trial, God will deliver us to a place of rest.

S/N	Location	Complaints	God's action	Now what for us?
4.	Desert of Sin (Exod 16:1)	<p>Not enough food.</p> <p>[store overnight manna. Collect manna on the Sabbath]</p>	<p>(a) Manna in the morning (b) Quail in the evening</p> <p>[The manna turned bad the next morning. No manna to be collected on the Sabbath.]</p>	<p>Pray and trust God.</p> <p>[The Israelites had little trust in God. So are we guilty of little trust.]</p>

S/N	Location	Complaints	God's action	Now what for us?
5.	Rephidim (Exod 17:1)	<ul style="list-style-type: none"> • No water to drink • Wanted to stone Moses • Exod 17:3,7 <p>[Attacked by the Amalekites]</p>	<p>God provided water from the rocks.</p> <p>[God gave the Israelites victory]</p>	Do not be ungrateful and challenge God.